



Marco Cable Management has further enhanced the company reputation as one of the leading British manufacturers of cable management systems, by the continued growth in innovative products and supportive accessories.

The Steel Wire Cable Tray accessories have been further expanded to include a new range of fast fix designs. These enable a reduced installation time on-site.

These additions allow Marco to offer a full range of accessories for every Steel Wire Cable Tray installation requirement.

The Fast Fix Universal Strut Clip allows the tray to be fastened to strut both quickly and easily, whilst maintaining a sturdy support. Supplied in packs of 50, the Strut Clip is made secure with one turn of a screwdriver and can be utilised in both new build and re-fit schemes, where strut channel is specified. Made from sprung steel, the Strut Clip has a chromium-free geomet finish. This is used specifically for small accessories, providing a smooth finish.

Latest accessories also include the Quick Fix Riser, used to attach the tray to the wall when being installed vertically in a rising situation; the Divider Joining Bracket, used to join two lengths of steel segregating divider together; the Multi Fix Plate – this part can be attached to the side or bottom of the tray and can attach light fittings or accessories; the Universal Support Bracket, used for attaching mounting boxes or industrial switches to the tray and the Earthing Terminal, ensuring a safe earth bond is achieved within the installation.



Standards

Marco Steel Wire Cable Tray conforms to the following standards:
BSEN 61537:2007, IEC 61537



STEEL WIRE CABLE TRAY accessories

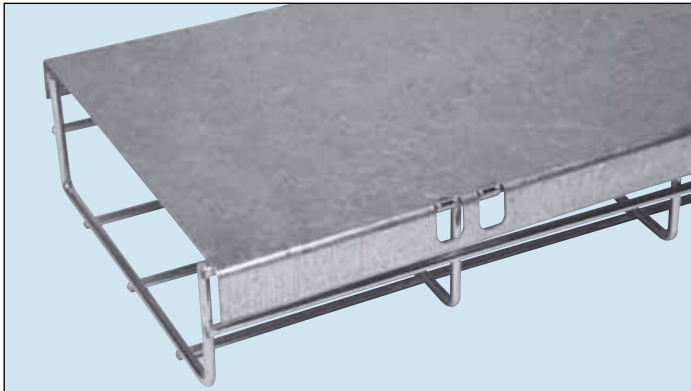

MCL - STEEL WIRE CABLE TRAY LID



MCD - STEEL WIRE CABLE TRAY DIVIDERS

Code No	Description	Tray Width	Finish	Pack Size
MCL100	Wire Tray Lid - 2m long	100mm	PG	1
MCL150	Wire Tray Lid - 2m long	150mm	PG	1
MCL200	Wire Tray Lid - 2m long	200mm	PG	1
MCL300	Wire Tray Lid - 2m long	300mm	PG	1
MCL400	Wire Tray Lid - 2m long	400mm	PG	1
MCL450	Wire Tray Lid - 2m long	450mm	PG	1
MCL500	Wire Tray Lid - 2m long	500mm	PG	1
MCL600	Wire Tray Lid - 2m long	600mm	PG	1

Code No	Size	Finish	Pack Size
MCD30	30mm x 3m	PG	1
MCD55	55mm x 3m	PG	1
MCD106	106mm x 3m	PG	1



MCQC

QUICK COUPLER

FINISH: EZ GT

PACK SIZE: 50

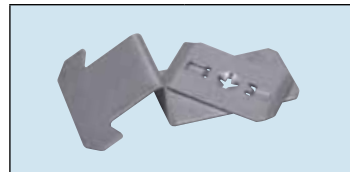
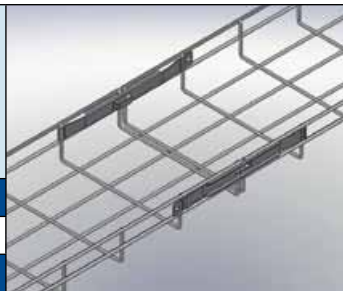

MCFUSC

FAST FIX UNIVERSAL STRUT CLIP

FINISH: GT

PACK SIZE: 50

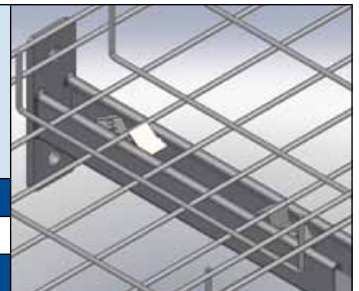

MCQLS

QUICK LOCK SMALL (FOR TRAYS FROM 100mm to 200mm)

FINISH: EZ

PACK SIZE: 25



MCQLL

QUICK LOCK LARGE (FOR TRAYS FROM 300mm to 600mm)

FINISH: EZ

PACK SIZE: 25

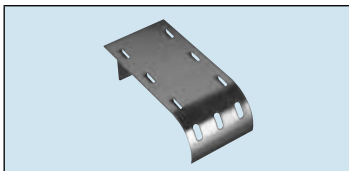

MCDOP

DROP OUT PLATE

FINISH: PG

PACK SIZE: 1

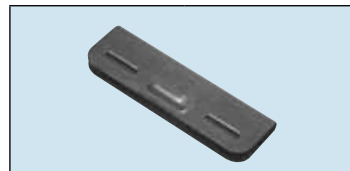
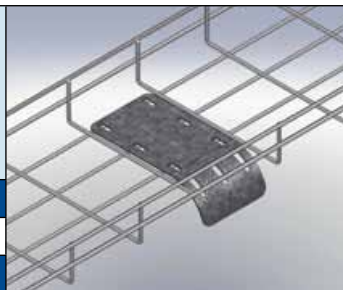

MCDJB

DIVIDER JOINING BRACKET

FINISH: EZ

PACK SIZE: 50



Finishes: Electro-zinc (EZ) Hot-dip galvanised (HDG) Pre-galvanised (PG) Geomet (GT) Stainless Steel (SS)

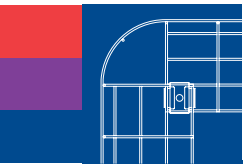

STEEL WIRE CABLE TRAY

accessories

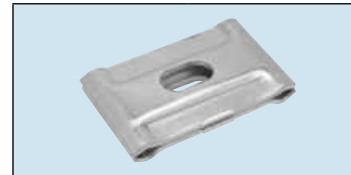

MCCL
CLAMP LARGE - HOLE DIAMETER 6.5mm
FINISH: EZ GT SS PACK SIZE: 50

MCSH
SUSPENSION HANGER - HOLE DIAMETER 10.2mm
FINISH: EZ GT SS PACK SIZE: 25 pairs MAXIMUM SAFE WORKING LOAD (KG): 100

MCFCP
FLEXIBLE CONDUIT PLATE (NOT SUITABLE FOR 75mm DEEP RANGE)
FINISH: EZ GT SS PACK SIZE: 1 CONDUIT HOLE DIAMETERS 20 & 25mm

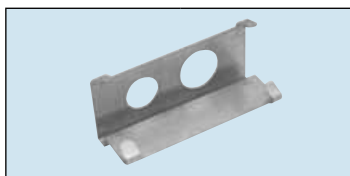
MCFCP3
FLEXIBLE CONDUIT PLATE 32mm GLAND
FINISH: PG PACK SIZE: 1 CONDUIT HOLE DIAMETERS 22, 25 & 32mm

MCQFR
QUICK FIX RISER
FINISH: EZ PACK SIZE: 1

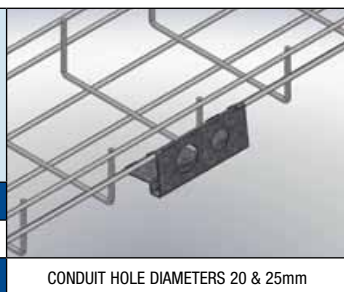
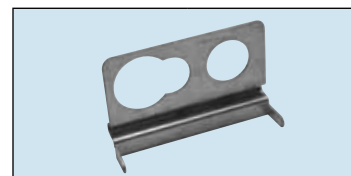

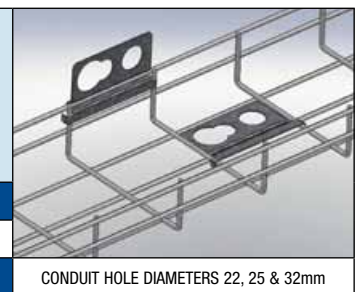
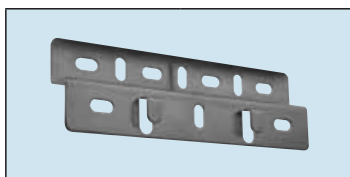

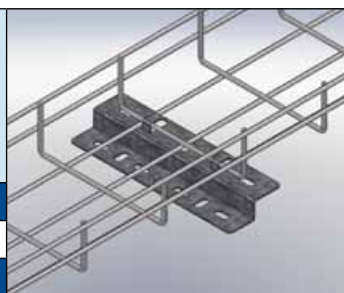
MCAMP
WALL BRACKET/ACC MOUNTING PLATE
FINISH: EZ SS PACK SIZE: 1 MAXIMUM SAFE WORKING LOAD (KG): 100

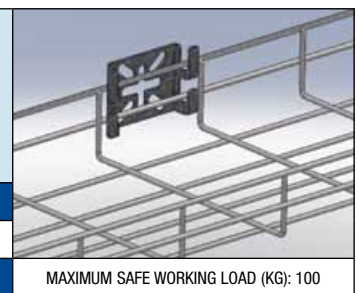
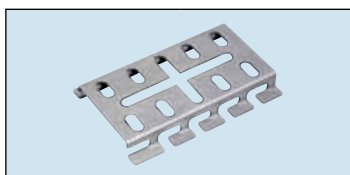
MCMFP
MULTI FIX PLATE
FINISH: EZ PACK SIZE: 1

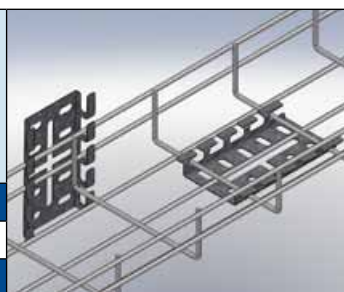
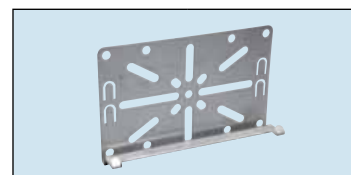
MCUSB
UNIVERSAL SUPPORT BRACKET
FINISH: PG PACK SIZE: 1

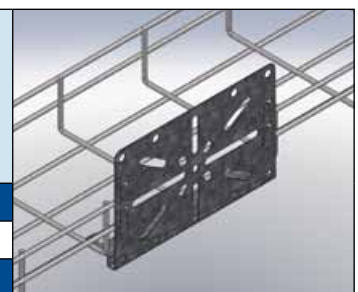

Finishes: Electro-zinc (EZ) Hot-dip galvanised (HDG) Pre-galvanised (PG) Geomet (GT) Stainless Steel (SS)



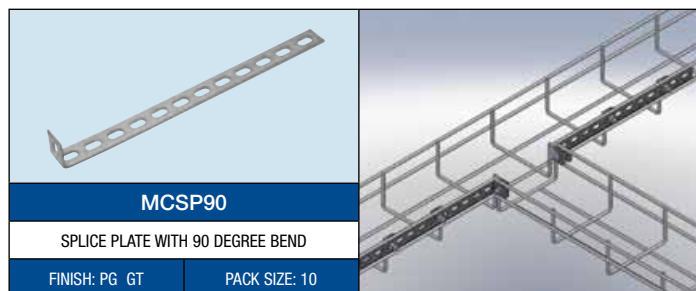
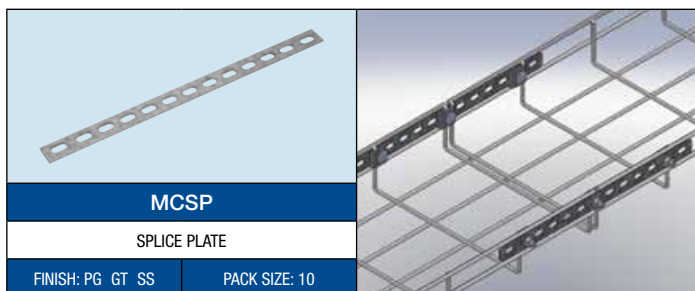
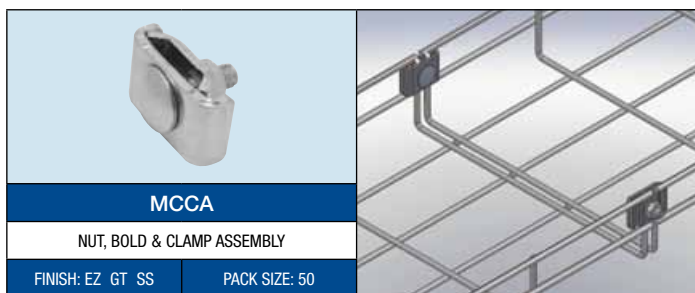

Finishes: Electro-zinc (EZ) Hot-dip galvanised (HDG) Pre-galvanised (PG) Geomet (GT) Stainless Steel (SS)



* Images shown in situ as part of an assembly

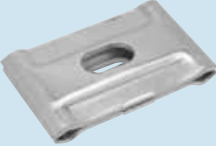
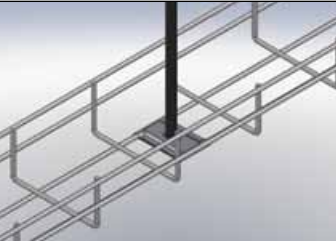

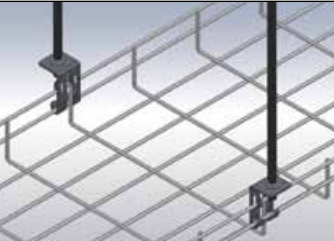

STEEL WIRE CABLE TRAY accessories



		
MCSH		
SUSPENSION HANGER - HOLE DIAMETER 10.2mm		
FINISH: EZ GT SS	PACK SIZE: 25 pairs	MAXIMUM SAFE WORKING LOAD (KG): 100

		
MCSB68		
SUSPENSION BRACKET FOR 6 & 8mm THREADED ROD		
FINISH: EZ	PACK SIZE: 2	MAXIMUM SAFE WORKING LOAD (KG): 100

		
MCSB102		
SUSPENSION BRACKET FOR 10 & 12mm THREADED ROD		
FINISH: EZ	PACK SIZE: 2	MAXIMUM SAFE WORKING LOAD (KG): 100

		
MCSB50		
SUSPENSION BRACKET FOR MC3050 & MC5550		
FINISH: PG	PACK SIZE: 1	MAXIMUM SAFE WORKING LOAD (KG): 30

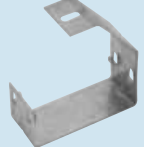

		
MCSB100		
SUSPENSION BRACKET FOR MC30100 & MC55100		
FINISH: PG	PACK SIZE: 1	MAXIMUM SAFE WORKING LOAD (KG): 30

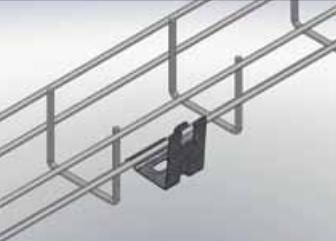
		
MCSB150		
SUSPENSION BRACKET FOR MC30150 & MC55150		
FINISH: PG	PACK SIZE: 1	MAXIMUM SAFE WORKING LOAD (KG): 30

		
MCB35		
BRACKET FOR MC3050 & MC5550		
FINISH: PG	PACK SIZE: 1	MAXIMUM SAFE WORKING LOAD (KG): 20

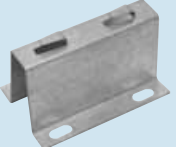
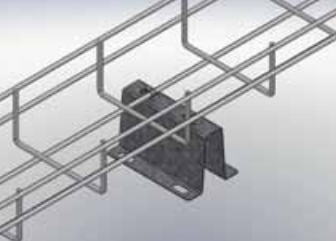
		
MCTS35		
TRAY SUPPORT BRACKET FOR MC3050 & MC5550		
FINISH: EZ SS	PACK SIZE: 1	

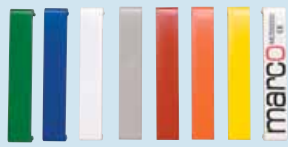
		
MCFFB		
FAST FIX FLOOR BRACKET		
FINISH: PG	PACK SIZE: 1	MAXIMUM SAFE WORKING LOAD (KG): 150

		
MCTAG		
MCTAG (available in various colours)		
FINISH: uPVC	PACK SIZE: 10	

	
MCROP	
WIRE CUTTERS	
PACK SIZE: 1	

Finishes:

Electro-zinc (EZ) Hot-dip galvanised (HDG) Pre-galvanised (PG) Geomet (GT) Stainless Steel (SS)



STEEL WIRE CABLE TRAY accessories

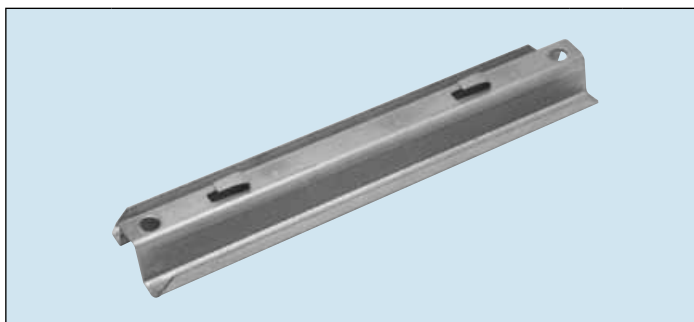

CODE NO	DESCRIPTION	FINISH	PACK SIZE
MCCSB100	FAST FIX CHANNEL SUPPORT BRACKET for 100mm Wide Tray, 200mm Long	PG	1
MCCSB150	FAST FIX CHANNEL SUPPORT BRACKET for 150mm Wide Tray, 250mm Long	PG	1
MCCSB200	FAST FIX CHANNEL SUPPORT BRACKET for 200mm Wide Tray, 300mm Long	PG	1
MCCSB300	FAST FIX CHANNEL SUPPORT BRACKET for 300mm Wide Tray, 400mm Long	PG	1
MCCSB400	FAST FIX CHANNEL SUPPORT BRACKET for 400mm Wide Tray, 500mm Long	PG	1
MCCSB450	FAST FIX CHANNEL SUPPORT BRACKET for 450mm Wide Tray, 550mm Long	PG	1
MCCSB500	FAST FIX CHANNEL SUPPORT BRACKET for 500mm Wide Tray, 600mm Long	PG	1
MCCSB600	FAST FIX CHANNEL SUPPORT BRACKET for 600mm Wide Tray, 700mm Long	PG	1

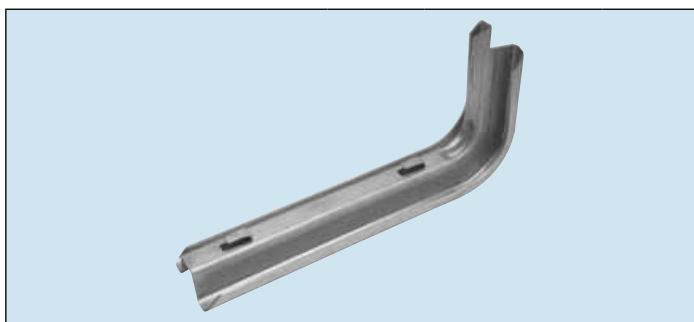

CODE NO	DESCRIPTION	TRAY WIDTH	FINISH	PACK SIZE	*LOAD - Kg
MCWFB100	FAST FIX WALL BRACKET	100mm	PG	1	175
MCWFB150	FAST FIX WALL BRACKET	150mm	PG	1	200
MCWFB200	FAST FIX WALL BRACKET	200mm	PG	1	140
MCWFB300	FAST FIX WALL BRACKET	300mm	PG	1	100
MCWFB400	FAST FIX WALL BRACKET	400mm	PG	1	95
MCWFB450	FAST FIX WALL BRACKET	450mm	PG	1	70

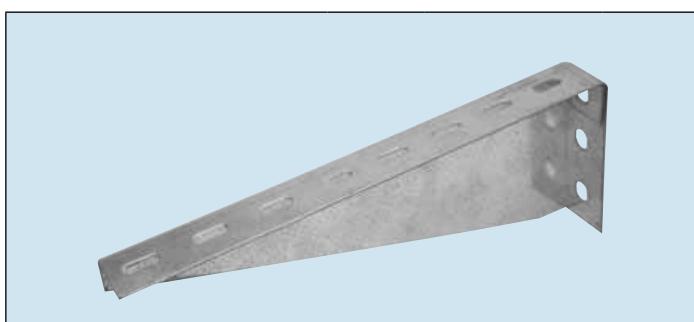

CODE NO	DESCRIPTION	TRAY WIDTH	FINISH	PACK SIZE	*LOAD - Kg
MCCB100	CANTILEVER BRACKET	100mm	PG	1	200
MCCB150	CANTILEVER BRACKET	150mm	PG	1	180
MCCB200	CANTILEVER BRACKET	200mm	PG	1	250
MCCB300	CANTILEVER BRACKET	300mm	PG	1	200
MCCB400	CANTILEVER BRACKET	400mm	PG	1	180

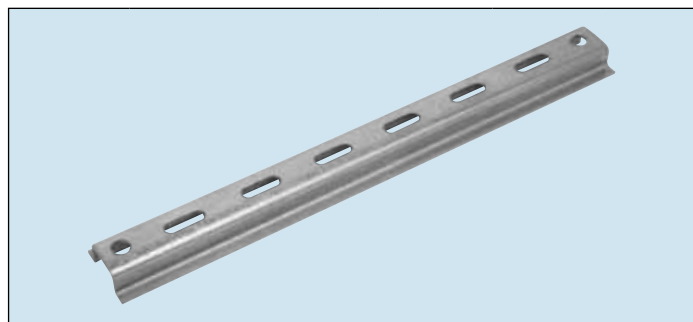

CODE NO	DESCRIPTION	TRAY WIDTH	FINISH	PACK SIZE
MCSC100	SUPPORT CHANNEL	50mm	PG	1
MCSC150	SUPPORT CHANNEL	100mm	PG	1
MCSC200	SUPPORT CHANNEL	150mm	PG	1
MCSC250	SUPPORT CHANNEL	200mm	PG	1
MCSC350	SUPPORT CHANNEL	300mm	PG	1
MCSC450	SUPPORT CHANNEL	400mm	PG	1
MCSC500	SUPPORT CHANNEL	450mm	PG	1
MCSC550	SUPPORT CHANNEL	500mm	PG	1
MCSC650	SUPPORT CHANNEL	600mm	PG	1



CODE NO	DESCRIPTION	TRAY WIDTH	FINISH	PACK SIZE	*LOAD - Kg
MCCFB100	FAST FIX CEILING BRACKET	100mm	PG	1	135
MCCFB150	FAST FIX CEILING BRACKET	150mm	PG	1	125
MCCFB200	FAST FIX CEILING BRACKET	200mm	PG	1	90
MCCFB300	FAST FIX CEILING BRACKET	300mm	PG	1	75
MCCFB400	FAST FIX CEILING BRACKET	400mm	PG	1	50
MCCFB450	FAST FIX CEILING BRACKET	450mm	PG	1	44

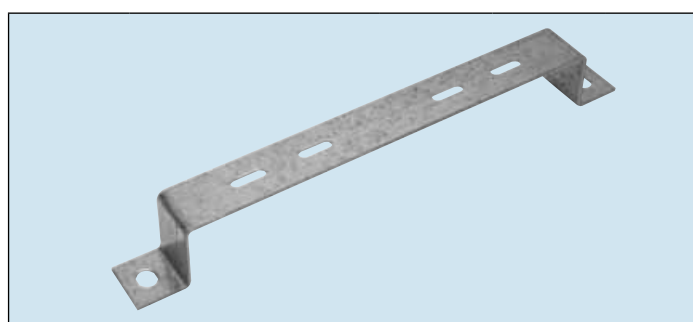

CODE NO	DESCRIPTION	TRAY WIDTH	FINISH	PACK SIZE
MCWB50	WALL/FLOOR BRACKET	50mm	PG	1
MCWB100	WALL/FLOOR BRACKET	100mm	PG	1
MCWB150	WALL/FLOOR BRACKET	150mm	PG	1
MCWB200	WALL/FLOOR BRACKET	200mm	PG	1
MCWB300	WALL/FLOOR BRACKET	300mm	PG	1
MCWB400	WALL/FLOOR BRACKET	400mm	PG	1
MCWB450	WALL/FLOOR BRACKET	450mm	PG	1
MCWB500	WALL/FLOOR BRACKET	500mm	PG	1
MCWB600	WALL/FLOOR BRACKET	600mm	PG	1

Finishes: Electro-zinc (EZ) Hot-dip galvanised (HDG) Pre-galvanised (PG) Geomet (GT)

*Maximum Safe Working Load